

No. 8209BP

# "BALL POINT" L-wrenches



Inclining the wrench moves the driving points toward the entry of the hexagon screw head recess. Even if the neck place of the ball point is thick, the wrench can be inclined up to 38°, the maximum tilting angle.

Magnetized tip can retain a hexagon screw head bolt.

Constricted neck design with hexagonal shape enables to retain a hexagon screw head bolt firmly. Easy to replace bolts located in a deep place.

## Resistant to twist and breaking Extra Superalloy

Made in Japan (except 8300HX-S)

With our new L-Wrench technology and design you will be able to perform the final tightening of your work even with the ball point shape.

## One point TORX Wrench Series

Quick tightening at tilted angle.

Max Tilting Angle **25°**  
(Designed value)

Ball-shaped TORX wrench. Can tighten screws quickly at a tilted angle. Ideal for a work in a cramped space such as automotive maintenance.



Can be used with tamper-proof screws.

Tamper-proof TORX screw has a protrusion in the center of the screw recess, and a standard TORX screwdriver cannot tighten or loosen such screw.

\*Screws with a protrusion different from the standard TORX cannot be handled.



**TORX**® Tip-end processing based on TORX standards. Corresponds to various screws.

No. 8209BP

"BALL POINT"  
Wrench  
Stubby 9-PC Set

L-shape angle 95° for easy handling. The arm length is half of the standard arm size.

HAND TOOLS

BITS & SOCKETS

ELECTRIC TOOLS

AIR TOOLS

STATIC SOLUTIONS

GASOLINE ENGINE TOOLS

### No. 8200BP-S Ball Point Wrench Stubby (Short Type) **NEW**



- New ball shape with the maximum tilted angle of 38° (design value in our company).
  - Stubby ideal for cramped spaces
  - L-shape angle 95° for easy handling.
- The arm length is half of the standard arm size.



No.8200BP-S

Size (mm)	Length (mm)	Width (mm)	Package Size (mm)	Inner Ctn.	EDP No.
1.5	4	52	160×45×5	10	143887
2	5	58	160×45×5	10	143888
2.5	6	60	160×45×5	10	143889
3	8	65	160×45×5	10	143890
4	9	72	200×60×8	10	143891
5	11	80	200×60×8	10	143892
6	13	90	200×60×8	10	143893
8	16	100	235×75×14	5	143894
10	19	112	235×75×14	5	143895

### No. 8200BP Ball Point Wrench Stubby **NEW**



- New ball shape with the maximum tilted angle of 38° (design value in our company).
  - Stubby ideal for cramped spaces
  - L-shape angle 95° for easy handling.
- The arm length is half of the standard arm size.



No.8200BP

Size (mm)	Length (mm)	Width (mm)	Package Size (mm)	Inner Ctn.	EDP No.
1.5	4	79	160×45×5	10	143897
2	5	86	160×45×5	10	143898
2.5	6	94	200×60×8	10	143899
3	8	101	200×60×8	10	143900
4	9	110	200×60×8	10	143901
5	11	120	200×60×8	10	143902
6	13	133	200×60×8	10	143903
8	16	154	235×75×14	5	143904
10	19	172	235×75×14	5	143905

### No. 8200BP-L Ball Point Wrench Stubby (Long Type) **NEW**



- New ball shape with the maximum tilted angle of 38° (design value in our company).
  - Stubby ideal for cramped spaces
  - L-shape angle 95° for easy handling.
- The arm length is half of the standard arm size.



No.8200BP-L

Size (mm)	Length (mm)	Width (mm)	Package Size (mm)	Inner Ctn.	EDP No.
1.5	4	79	160×45×5	10	143907
2	5	95	200×60×8	10	143908
2.5	6	110	200×60×8	10	143909
3	8	126	200×60×8	10	143910
4	9	142	200×60×8	10	143911
5	11	160	235×75×14	5	143912
6	13	180	235×75×14	5	143913
8	16	200	280×65×14	5	143914
10	19	224	350×75×14	5	143915

### No. 8209BP-S Ball Point Wrench Stubby (Short Type) 9PC Set **NEW**

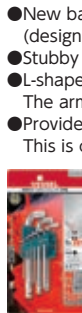

- New ball shape with the maximum tilted angle of 38° (design value in our company).
  - Stubby ideal for cramped spaces
  - L-shape angle 95° for easy handling.
- The arm length is half of the standard arm size.
- Provided with a convenient portable holder.
- This is openable facilitating to pick a necessary size.

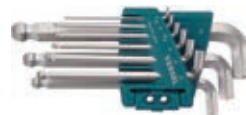

No.8209BP-S

Set content		Package size (mm)	Inner Ctn.	EDP No.
8209BP-S	H 1.5, 2, 2.5, 3, 4, 5, 6, 8, 10 mm	200×105×27	5	143896
Accessory	Holder			

### No. 8209BP Ball Point Wrench Stubby 9PC Set **NEW**

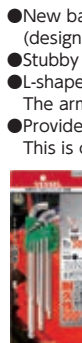

- New ball shape with the maximum tilted angle of 38° (design value in our company).
  - Stubby ideal for cramped spaces
  - L-shape angle 95° for easy handling.
- The arm length is half of the standard arm size.
- Provided with a convenient portable holder.
- This is openable facilitating to pick a necessary size.



No.8209BP

Set content		Package size (mm)	Inner Ctn.	EDP No.
8209BP	H 1.5, 2, 2.5, 3, 4, 5, 6, 8, 10 mm	245×105×27	5	143906
Accessory	Holder			

### No. 8209BP-L Ball Point Wrench Stubby (Long Type) 9PC Set **NEW**



- New ball shape with the maximum tilted angle of 38° (design value in our company).
  - Stubby ideal for cramped spaces
  - L-shape angle 95° for easy handling.
- The arm length is half of the standard arm size.
- Provided with a convenient portable holder.
- This is openable facilitating to pick a necessary size.



No.8209BP-L

Set content		Package size (mm)	Inner Ctn.	EDP No.
8209BP-L	H 1.5, 2, 2.5, 3, 4, 5, 6, 8, 10 mm	295×105×27	10	143916
Accessory	Holder			

**No. 8300BP Ball Point Wrench NEW**

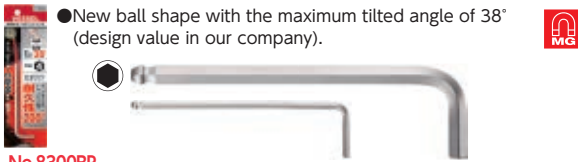

- New ball shape with the maximum tilted angle of 38° (design value in our company).



(mm)			Package Size (mm)	Inner Ctn.	EDP No.
1.5	16	79	160×45×5	10	143917
2	17	86	160×45×5	10	143918
2.5	18	94	200×60×8	10	143919
3	20	101	200×60×8	10	143920
4	25	110	200×60×8	10	143921
5	28	120	200×60×8	10	143922
6	32	133	200×60×8	10	143923
8	36	154	235×75×14	5	143924
10	40	172	235×75×14	5	143925

**No. 8309BP Ball Point Wrench 9PC Set NEW**



- New ball shape with the maximum tilted angle of 38° (design value in our company).
- Provided with a convenient portable holder. This is openable facilitating to pick a necessary size.



Set content		Package size (mm)	Inner Ctn.	EDP No.
8309BP	H 1.5, 2, 2.5, 3, 4, 5, 6, 8, 10 mm	245×105×27	5	143926
Accessory	Holder			

**No. 8300BP-L Ball Point Wrench (Long Type) NEW**



- New ball shape with the maximum tilted angle of 38° (design value in our company).
- Ball point can reach deep spaces. Also, it is possible to apply force on the arm end.



(mm)			Package Size (mm)	Inner Ctn.	EDP No.
1.5	16	79	160×45×5	10	143927
2	17	95	200×60×8	10	143928
2.5	18	110	200×60×8	10	143929
3	20	126	200×60×8	10	143930
4	25	142	200×60×8	10	143931
5	28	160	235×75×14	5	143932
6	32	180	235×75×14	5	143933
8	36	200	280×65×14	5	143934
10	40	224	350×75×14	5	143935
12	45	250	No Card	-	143936
14	55	280	No Card	-	143937
17	60	320	No Card	-	143938
19	70	360	No Card	-	143939

**No. 8309BP-L Ball Point Wrench (Long Type) 9PC Set NEW**



- New ball shape with the maximum tilted angle of 38° (design value in our company).
- Ball point can reach deep spaces. Also, it is possible to apply force on the arm end.
- Provided with a convenient portable holder. This is openable facilitating to pick a necessary size.



Set content		Package size (mm)	Inner Ctn.	EDP No.
8309BP-L	H 1.5, 2, 2.5, 3, 4, 5, 6, 8, 10 mm	295×105×27	10	143940
Accessory	Holder			

**No. 8300BP-XL Ball Point Wrench (Extra Long Type) NEW**



- New ball shape with the maximum tilted angle of 38° (design value in our company).
- Ball point can reach deep spaces. Also, it is possible to apply force on the arm end.



(mm)			Package Size (mm)	Inner Ctn.	EDP No.
1.5	16	91	160×45×5	10	143951
2	17	109	200×60×8	10	143952
2.5	18	132	200×60×8	10	143953
3	20	151	200×60×8	10	143954
4	25	170	235×75×14	5	143955
5	28	200	280×65×14	5	143956
6	32	225	280×65×14	5	143957
8	36	260	350×75×14	5	143958
10	40	291	350×75×14	5	143959

**No. 8309BP-XL Ball Point Wrench (Extra Long Type) 9PC Set NEW**

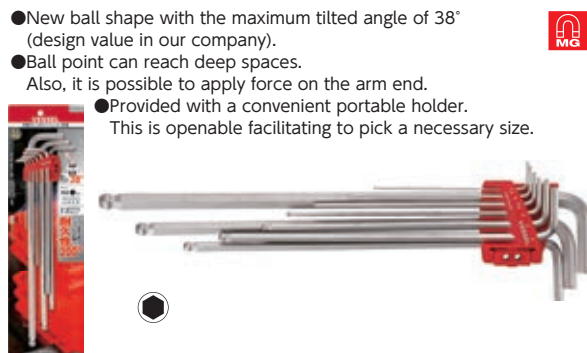

- New ball shape with the maximum tilted angle of 38° (design value in our company).
- Ball point can reach deep spaces. Also, it is possible to apply force on the arm end.
- Provided with a convenient portable holder. This is openable facilitating to pick a necessary size.



Set content		Package size (mm)	Inner Ctn.	EDP No.
8309BP-XL	H 1.5, 2, 2.5, 3, 4, 5, 6, 8, 10 mm	350×105×27	10	143960
Accessory	Holder			

HAND TOOLS  
BITS & SOCKETS  
ELECTRIC TOOLS  
AIR TOOLS  
STATIC SOLUTIONS  
GASOLINE ENGINE TOOLS



### No. 8300BP-LIN Ball Point Wrench (Long Type) (Inch) **NEW**



- New ball shape with the maximum tilted angle of 38° (design value in our company).
- Ball point can reach deep spaces.  
Also, it is possible to apply force on the arm end.



No.8300BP-LIN

	⌀	⊥	⊥ (mm)	Package Size (mm)	Inner Ctn.	EDP No.
1/16	15	79		160×45×5	10	143941
5/64	17	93		200×60×8	10	143942
3/32	18	108		200×60×8	10	143943
1/8	20	127		200×60×8	10	143944
5/32	25	140		200×60×8	10	143945
3/16	28	158		235×75×14	5	143946
1/4	32	178		235×75×14	5	143947
5/16	36	198		280×65×14	5	143948
3/8	40	222		350×75×14	5	143949

### No. 8309BP-LIN Ball Point Wrench (Long Type) (Inch) 9PC Set **NEW**



- New ball shape with the maximum tilted angle of 38° (design value in our company).
- Ball point can reach deep spaces.  
Also, it is possible to apply force on the arm end.
- Provided with a convenient portable holder.  
This is openable facilitating to pick a necessary size.



No.8309BP-LIN

Set content		Package size (mm)	Inner Ctn.	EDP No.
8309BP-LIN	A/F 1/16, 5/64, 3/32, 1/8, 5/32, 3/16, 1/4, 5/16, 3/8 inch	295×105×20	10	143950
Accessory	Holder			

### No. 8500BTX Ball End TORX Wrench **NEW**



- Can tighten screws quickly at a tilted angle. Ideal for a work in a cramped space such as automotive maintenance.



No.8500BTX

	⌀	⊥	⊥ (mm)	Package Size (mm)	Inner Ctn.	EDP No.
T8	16	80		160×45×5	10	143961
T9	16	80		160×45×5	10	143962
T10	17	90		160×45×5	10	143963
T15	18	100		200×60×8	10	143964
T20	19	112		200×60×8	10	143965
T25	20	126		200×60×8	10	143966
T27	25	140		200×60×8	10	143967
T30	28	160		235×75×14	5	143968
T40	32	180		235×75×14	5	143969

### No. 8509BTX Ball End TORX Wrench 9PC Set **NEW**



- Can tighten screws quickly at a tilted angle. Ideal for a work in a cramped space such as automotive maintenance.
- Provided with a convenient portable holder.  
This is openable facilitating to pick a necessary size.



No.8509BTX

Set content		Package size (mm)	Inner Ctn.	EDP No.
8509BTX	Size T8, T9, T10, T15, T20, T25, T27, T30, T40 mm	245×105×27	5	143970
Accessory	Holder			

### No. 8500TXH Tamper-proof TORX Wrench **NEW**



- Can be used with tamper-proof screws. Automotive, Motorcycle, Telecommunication devices, PC, etc.



No.8500TXH

	⌀	⊥	⊥ (mm)	Package Size (mm)	Inner Ctn.	EDP No.
T8H	16	80		160×45×5	10	143971
T9H	16	80		160×45×5	10	143972
T10H	17	90		160×45×5	10	143973
T15H	18	100		200×60×8	10	143974
T20H	19	112		200×60×8	10	143975
T25H	20	126		200×60×8	10	143976
T27H	25	140		200×60×8	10	143977
T30H	28	160		235×75×14	5	143978
T40H	32	180		235×75×14	5	143979

### No. 8509TXH Tamper-proof TORX Wrench 9PC Set **NEW**



- Can be used with tamper-proof screws. Automotive, Motorcycle, Telecommunication devices, PC, etc.
- Provided with a convenient portable holder.  
This is openable facilitating to pick a necessary size.



No.8509TXH

Set content		Package size (mm)	Inner Ctn.	EDP No.
8509TXH	Size T8H, T9H, T10H, T15H, T20H, T25H, T27H, T30H, T40H mm	245×105×27	5	143980
Accessory	Holder			

**No. TW-H T-Handle Screwdriver NEW**



No.TW-H

Hex	Length (mm)	Width (mm)	Depth (mm)	Inner Ctn. (mm)	EDP No.
3	125	70	163	6	144361
4	140	70	178	6	144362
5	150	80	200	6	144363
6	155	120	223	-	144364
8	175	160	251	-	144365
10	200	160	276	-	144366

**No. TW-HIN T-Handle Screwdriver (Inch) NEW**



No.TW-HIN

Hex	Length (mm)	Width (mm)	Depth (mm)	Inner Ctn. (mm)	EDP No.
1/8	125	70	163	6	144367
5/32	140	70	178	6	144368
3/16	150	80	200	6	144369
1/4	155	120	223	-	144370
5/16	175	160	251	-	144371
3/8	200	160	276	-	144372

**No. FW-H Flag Handle Screwdriver NEW**



No.TW-H

Hex	Length (mm)	Width (mm)	Depth (mm)	Inner Ctn. (mm)	EDP No.
1.5	40	20	74	10	144373
2	40	20	74	10	144374
2.5	40	20	74	10	144375

**No. FW-HIN Flag Handle Screwdriver (Inch) NEW**



No.FW-HIN

Hex	Length (mm)	Width (mm)	Depth (mm)	Inner Ctn. (mm)	EDP No.
1/16	40	20	74	10	144376
5/64	40	20	74	10	144377
3/32	40	20	74	10	144378

**No. 8300HX-S Hex Wrench (Short Type) NEW**



No.8300HX-S

Hex	Length (mm)	Depth (mm)	Inner Ctn. (mm)	EDP No.
1.5	12.5	52.5	10	144060
2	12	58	10	144061
2.5	15	60	10	144062
3	20	65	10	144063
4	25	72	10	144064
5	28	80	10	144065
6	32	90	10	144066
8	36	100	5	144067
10	40	112	5	144068

HAND TOOLS  
BITS & SOCKETS  
ELECTRIC TOOLS  
AIR TOOLS  
STATIC SOLUTIONS  
GASOLINE ENGINE TOOLS

### No. 8900BP "RAINBALL" L-wrenches PAT.

- Easy to find in a toolbox. Color-coded by size. Coating is peel-proofed by manganese phosphate under coating.
- New ball shape. Set the driving part so that it contacts near the entry point of the hexagonal hole, with the maximum tilted angle of 38° (design value in our company). The cross-sectional area of the neck of the ball is enlarged to improve the strength.
- High precision black point tip, unaffected by metal plating.
- Cross-section is "Ultra-Hex", which has the 3-point and 3-surface contact geometry to reduce deforming of screw holes.



No.8900BP	Set content	Package size (mm)	Inner Ctn.	EDP No.
H 1.5	1.5 13.5 67.5	160×45×5	10	144341
H 2	2 15.5 72	160×45×5	10	144342
H 2.5	2.5 17.5 81	160×45×5	10	144343
H 3	3 19 90.5	160×45×5	10	144344
H 4	4 24 98.5	200×60×8	10	144345
H 5	5 27 118.5	200×60×8	10	144346
H 6	6 31 138	200×60×8	10	144347
H 8	8 35 158	235×75×14	5	144348
H 10	10 39 178.5	235×75×14	5	144349

※Colors inside the table cells indicate the body color.

### No. 8409BP "ULTRABALL" L-wrenches 9PC Set PAT.

- New ball shape with the maximum tilted angle of 38° (design value in our company). The cross-sectional area of the neck of the ball is enlarged to improve the strength.
- Cross-section is "Ultra-Hex", which has the 3-point and 3-surface contact geometry to reduce deforming of screw holes.
- Provided with a convenient portable holder. This is openable facilitating to pick a necessary size.



Set content		Package size (mm)	Inner Ctn.	EDP No.
8400BP	H 1.5, 2, 2.5, 3, 4, 5, 6, 8, 10 mm	245×105×27	5	144353
Accessory	Holder			

### No. 8906BP "RAINBALL" L-wrenches 6PC Set PAT.

- Easy to find in a toolbox. Color-coded by size.
- New ball shape with the maximum tilted angle of 38° (design value in our company). The cross-sectional area of the neck of the ball is enlarged to improve the strength.
- Provided with a convenient portable holder.



Set content		Package size (mm)	Inner Ctn.	EDP No.
8900BP	H 1.5, 2, 2.5, 3, 4, 5 mm	200×80×13	5	144352
Accessory	Holder			

### No. 8909BP "RAINBALL" L-wrenches 9PC Set PAT.

- Provided with a holder that opens like a fan and utilized as a stand, together with a magnetizer.
- The magnetizer can be taken out from the holder and used to magnetize and demagnetize a wrench.

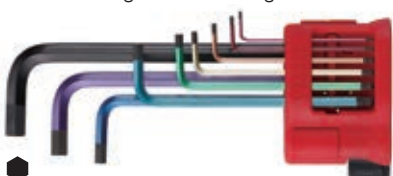

Set content		Package size (mm)	Inner Ctn.	EDP No.
8900BP	H 1.5, 2, 2.5, 3, 4, 5, 6, 8, 10 mm	245×105×27	5	144351
Accessory	Magnetizer/Holder			

## One point

### No.8409BP Ultra Ball

Unique ball configuration allowing the tip to incline 38° maximum facilitates tightening or loosening of screws!

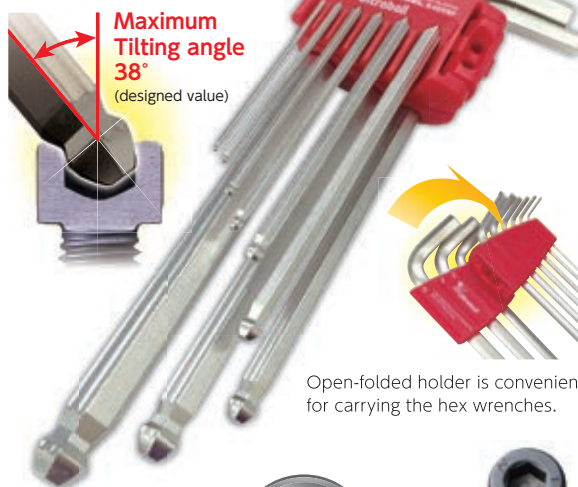
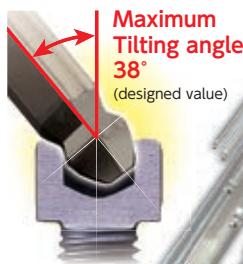

Open-folded holder is convenient for carrying the hex wrenches.

### Ultra Hex

Highly durable but no damage on screw surface! 3-point and 3-face contact hexagonal shape maximizes fastening effectiveness.



Surface Contact

